

DRAFT COPY

DO NOT SCALE. IF IN DOUBT ASK!

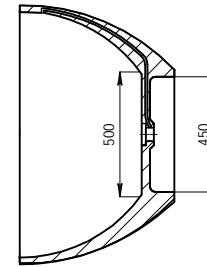

SECTION B-B

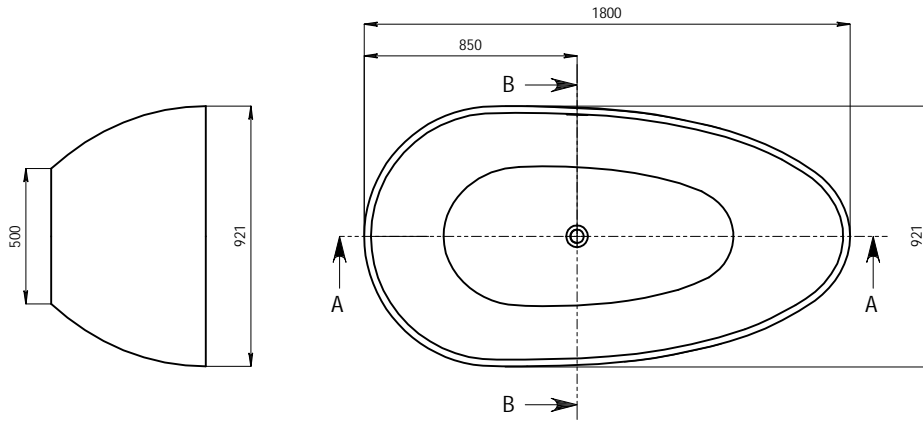
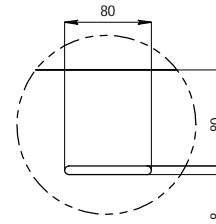
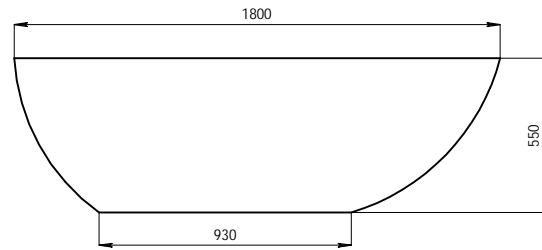
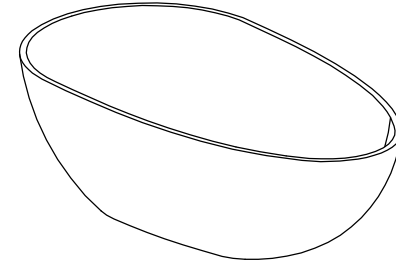

DETAIL C
SCALE 1:4

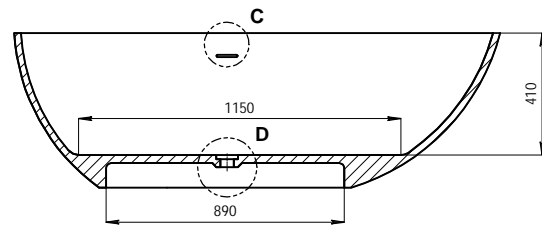

SECTION A-A

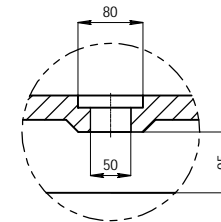

DETAIL D
SCALE 1:3

COLOUR
QTY
APPROVED BY:
NAME & SIGNATURE
DATE APPROVED:

- NOTES
1. ALL INTERNAL CORNERS TO BE R5 UNLESS OTHERWISE STATED.
 2. AS ALL KASKADE PRODUCTS ARE HAND FINISHED A 2-5mm TOLERANCE IS ALLOWED.

COPYRIGHT © APPLIES DUPPLICATION OF THIS DRAWING OR ANY SPECIFIC DESIGN FEATURES IS NOT PERMITTED WITHOUT WRITTEN AUTHORITY. "COMMERCIAL CONFIDENTIALITY" IS ASSUMED AND REQUIRED.

UNLESS OTHERWISE STATED ALL DIMENSIONS IN MILLIMETERS	MATERIAL:	KASKADE STONE	DRAWING NUMBER	Viva-RS3-1800	SCALE 1:1	A4		
	FINISH:	REFER TO ORDER			SHEET 1 OF 1	REV. 1		
DRAWING LEGEND	N.W	170 kg	Product Size	1800X921X550	 www.kaskadebaths.de			
	G.W	kg	Package size					
	LINEAR / ANGULAR TOLERANCES		DRAWN	KASKADE			DATE	02/03/15
	No Decimals	1 Decimal	2 Decimals	CHK'D			DATE	
	±5			±3°				

REV	DESCRIPTION	DWG	DATE	CHK'D	DATE
1	RELEASE DATE.	KASKADE	02/03/15		