

DRAFT COPY

DO NOT SCALE IF IN DOUBT ASK!

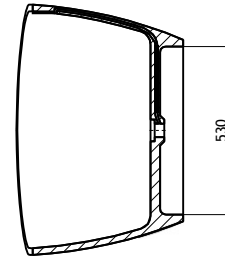

SECTION B-B

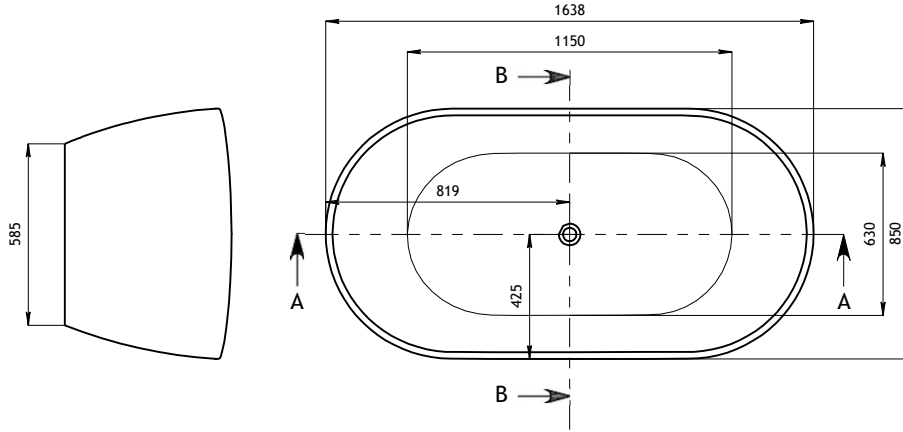
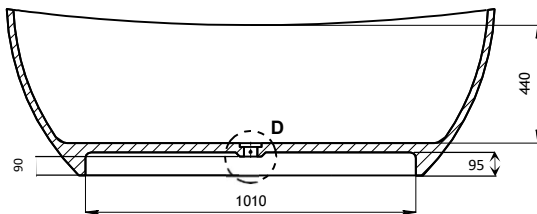
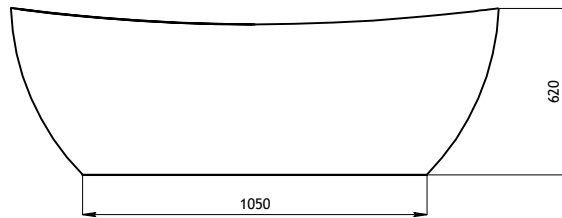
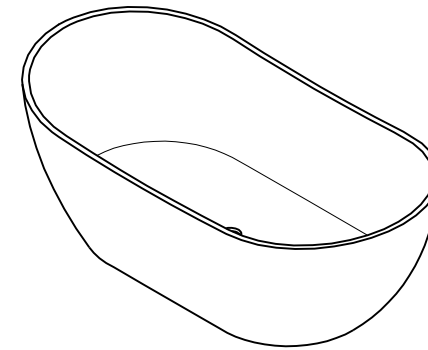

SECTION A-A

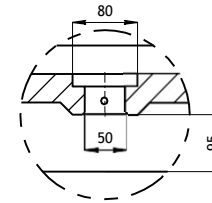

DETAIL D
SCALE 1:3

COLOUR
QTY
APPROVED BY:
NAME & SIGNATURE
DATE APPROVED:

NOTES

1. ALL INTERNAL CORNERS TO BERS UNLESS OTHERWISE STATED.
2. AS ALL KASKADE PRODUCTS ARE HAND FINISHED A 2.5mm TOLERANCE IS ALLOWED.

COPYRIGHT APPLIES. DUPLICATION OF THIS DRAWING OR ANY SPECIFIC DESIGN FEATURES IS NOT PERMITTED WITHOUT WRITTEN AUTHORITY. "COMMERCIAL CONFIDENTIALITY" IS ASSUMED AND REQUIRED.

UNLESS OTHERWISE STATED ALL DIMENSIONS IN MILLIMETERS		MATERIAL: KASKADE STONE	DRAWING NUMBER	
FINISH: REFER TO ORDER		Impro-RS24-1638		SCALE 1:1
DRAWING LEGEND		Product Size 1638X850X620		A4
N.W. 168 kg		Package size 1700x980x790		SHEET 1 OF 1 REV. 1
G.W. 218 kg		DRAWN: KASKADE DATE: 02/03/15		 www.kaskadebaths.de
LINEAR / ANGULAR TOLERANCES		DATE		
No Deviated / Deviated 2 (mm)		DATE		

REV	DESCRIPTION	DWG	DATE	CHKD	DATE
1	RELEASE DATE.	KASKADE	02/03/15		