

**DRAFT COPY**

DO NOT SCALE. IF IN DOUBT ASK!

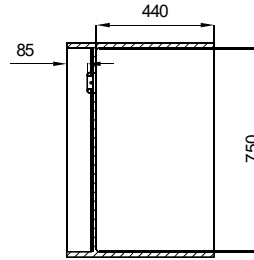

**SECTION B-B**

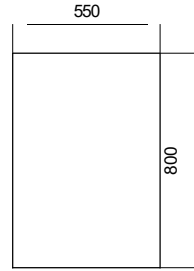
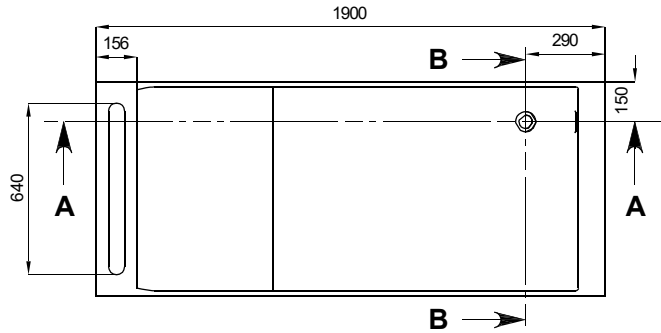
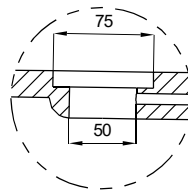
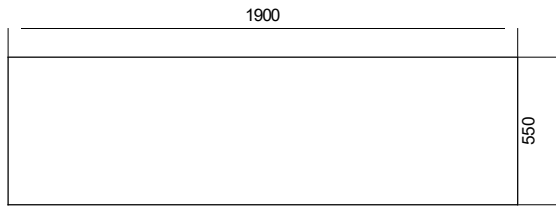
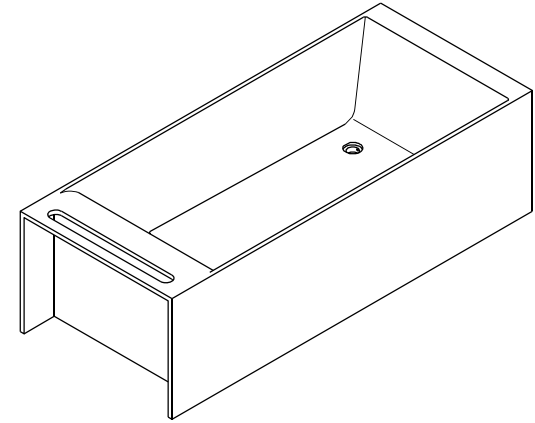

**DETAIL D  
SCALE 1:5**

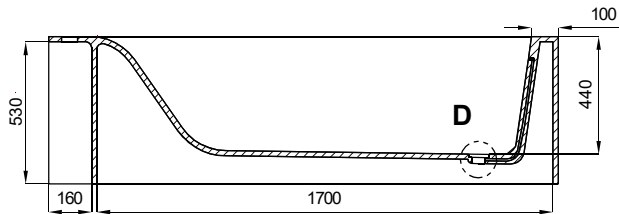

**SECTION A-A**

<b>COLOUR</b>
<b>QTY</b>
<b>APPROVED BY:</b>
NAME & SIGNATURE
<b>DATE APPROVED:</b>

**NOTES**

1. ALL INTERNAL CORNERS TO BE R5 UNLESS OTHERWISE STATED.
2. BASINS IN AUSTRALIA COME WITH GLOSS FINISH ONLY ON SPECIAL ORDER - 8 WEEKS DELAY (SURCHARGE APPLIES). ALL BASINS DO NOT COME WITH A WASTE FITTING.

COPYRIGHT © APPLIES. DUPLICATION OF THIS DRAWING OR ANY SPECIFIC DESIGN FEATURES IS NOT PERMITTED WITHOUT WRITTEN AUTHORITY. "COMMERCIAL CONFIDENTIALITY" IS ASSUMED AND REQUIRED.

UNLESS OTHERWISE STATED ALL DIMENSIONS IN MILLIMETERS		MATERIAL: <b>KASKADE STONE</b>	DRAWING NUMBER <b>Sirio-RS25</b>	SCALE 1:1	A4
DRAWING LEGEND		FINISH: REFER TO ORDER	Product Size 1900X800X550	SHEET 1 OF 1	REV. 1
		N.W. kg		 www.kaskadebaths.de	
		G.W. kg	Package size		
		LINEAR / ANGULAR TOLERANCES	DRAWN <b>KASKADE</b>	DATE <b>02/03/15</b>	
		No Decimals 1 Decimal 2 Decimals	CHK'D	DATE	
		±5 ±3°			

REV	DESCRIPTION	DWG	DATE	CHK'D	DATE
1	RELEASE DATE.	KASKADE	02/03/15		