

DRAFT COPY

DO NOT SCALE. IF IN DOUBT ASK!

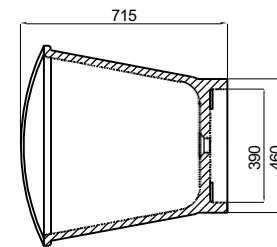

SECTION B-B

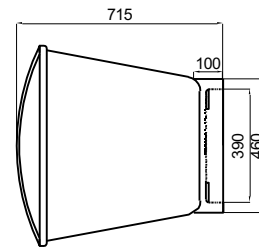
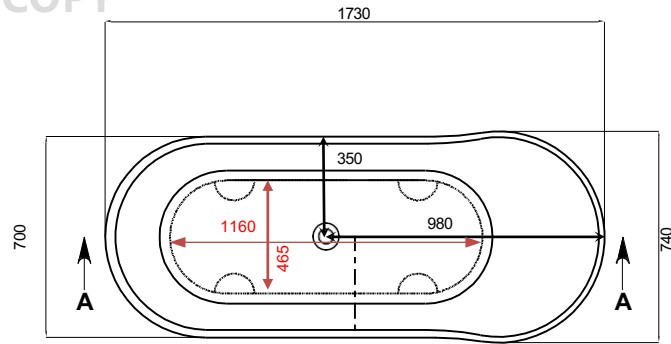
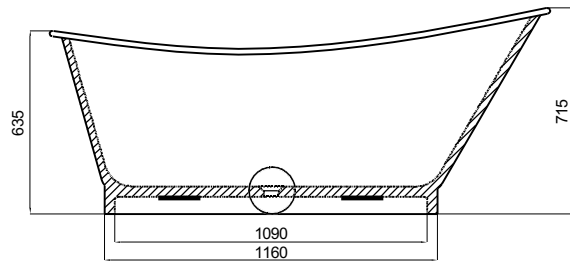
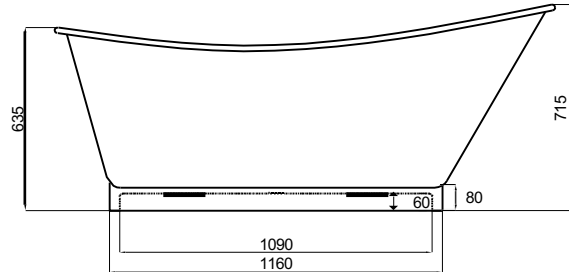

SECTION A-A

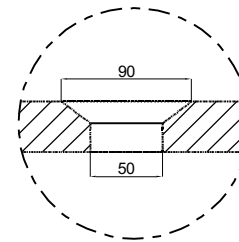

DETAIL D
SCALE 1:3

COLOUR
QTY
APPROVED BY:
NAME & SIGNATURE
DATE APPROVED:

NOTES

1. ALL INTERNAL CORNERS TO BE R5 UNLESS OTHERWISE STATED.
2. BASINS IN AUSTRALIA COME WITH GLOSS FINISH ONLY ON SPECIAL ORDER - 8 WEEKS DELAY (SURCHARGE APPLIES). ALL BASINS DO NOT COME WITH A WASTE FITTING.

REV	RELEASE DATE	DESCRIPTION	DWG	DATE	CHK'D	DATE
1			KASKADE	02/03/15		

COPYRIGHT © APPLIES DUPLICATION OF THIS DRAWING OR ANY SPECIFIC DESIGN FEATURES IS NOT PERMITTED WITHOUT WRITTEN AUTHORITY. "COMMERCIAL CONFIDENTIALITY" IS ASSUMED AND REQUIRED.

UNLESS OTHERWISE STATED ALL DIMENSIONS IN MILLIMETERS	MATERIAL	KASKADE STONE		DRAWING NUMBER	Elba-RS11		SCALE 1:1	A4
	FINISH	REFER TO ORDER				SHEET 1 OF 1		REV 1
DRAWING LEGEND	NW	149 kg	Product Size	1730X700X715		 KASKADE STONE www.kaskadebaths.de		
	GW		Package size					
	LINEAR / ANGULAR TOLERANCES	±0.1	DATE	02/03/15				
	NO DIMENSIONS IN PARENTHESIS	±0.3	DATE					