

DRAFT COPY

DO NOT SCALE. IF IN DOUBT ASK!

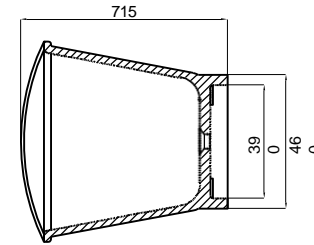

SECTION B-B

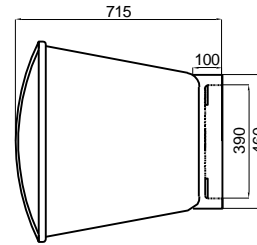
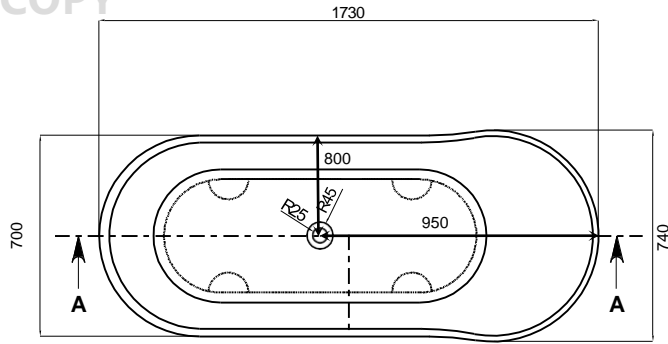
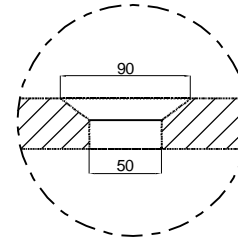
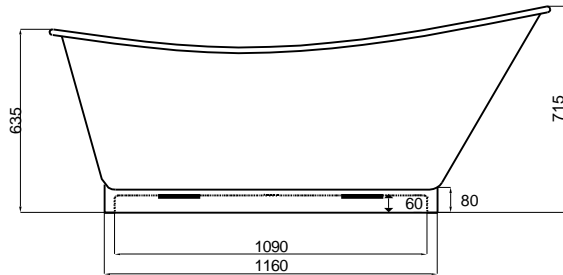

DETAIL D  
SCALE 1:3

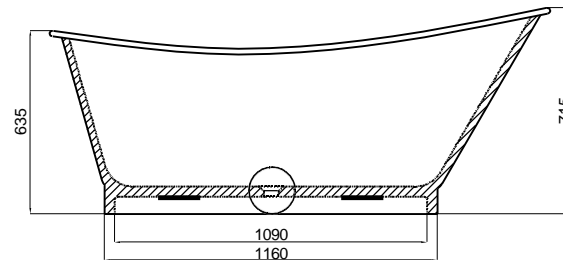

SECTION A-A

<b>COLOUR</b>
<b>QTY</b>
<b>APPROVED BY:</b>
<small>NAME &amp; SIGNATURE</small>
<b>DATE APPROVED:</b>

- NOTES
1. ALL INTERNAL CORNERS TO BE R5 UNLESS OTHERWISE STATED.
  2. BASINS IN AUSTRALIA COME WITH GLOSS FINISH ONLY ON SPECIAL ORDER - 8 WEEKS DELAY (SURCHARGE APPLIES). ALL BASINS DO NOT COME WITH A WASTE FITTING.

COPYRIGHT APPLIES. DUPLICATION OF THIS DRAWING OR ANY SPECIFIC DESIGN FEATURES IS NOT PERMITTED WITHOUT WRITTEN AUTHORITY. "COMMERCIAL CONFIDENTIALITY" IS ASSUMED AND REQUIRED.

UNLESS OTHERWISE STATED ALL DIMENSIONS IN MILLIMETERS		MATERIAL: KASKADE STONE	DRAWING NUMBER Elba-RS11	SCALE 1:1	A4
DRAWING LEGEND		FINISH: REFER TO ORDER	 KASKADE STONE www.kaskadebaths.de	SHEET 1 OF 1	REV. 1
N.W	149 kg	Product Size		1730X700X715	
G.W	kg	Package size			
LINEAR / ANGULAR TOLERANCES		DRAWN		KASKADE	DATE
No Decimals	±0.2mm	Normals	±0.3	DATE	
±5					

REV	DESCRIPTION	DWG	DATE	CHK'D	DATE
1	RELEASE DATE.	KASKADE	02/03/15		