

DRAFT COPY

DO NOT SCALE. IF IN DOUBT ASK!

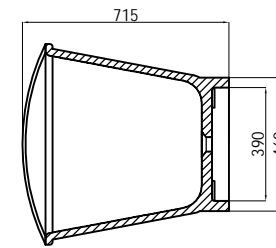

SECTION B-B

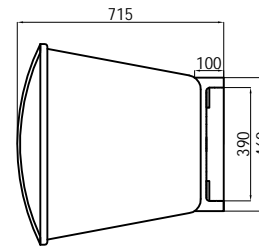
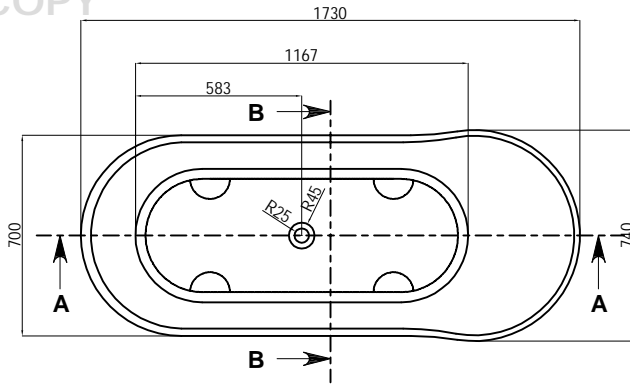
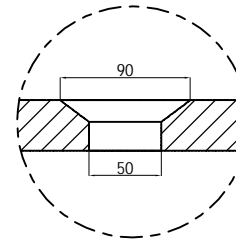
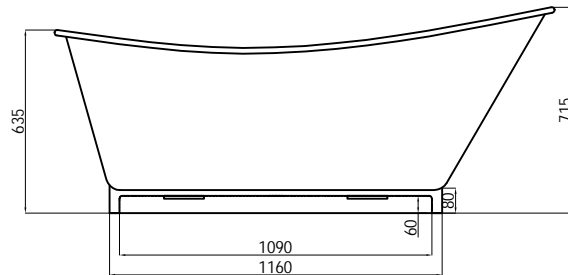

DETAIL D
SCALE 1:3

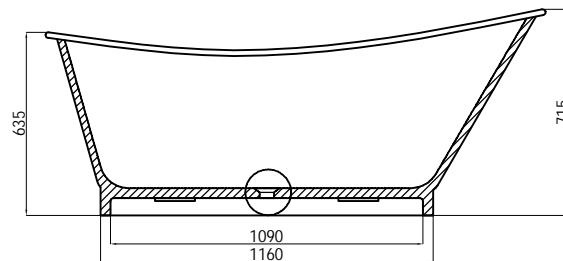



SECTION A-A

- NOTES
1. ALL INTERNAL CORNERS TO BE R5 UNLESS OTHERWISE STATED.
 2. BASINS IN AUSTRALIA COME WITH GLOSS FINISH ONLY ON SPECIAL ORDER - 8 WEEKS DELAY (SURCHARGE APPLIES). ALL BASINS DO NOT COME WITH A WASTE FITTING.

COLOUR
QTY
APPROVED BY:
NAME & SIGNATURE
DATE APPROVED:

COPYRIGHT © APPLIES. DUPLICATION OF THIS DRAWING OR ANY SPECIFIC DESIGN FEATURES IS NOT PERMITTED WITHOUT WRITTEN AUTHORITY. "COMMERCIAL CONFIDENTIALITY" IS ASSUMED AND REQUIRED.

UNLESS OTHERWISE STATED ALL DIMENSIONS IN MILLIMETERS	MATERIAL:	KASKADE STONE	DRAWING NUMBER	Elba-RS11	SCALE 1:1	A4		
	FINISH:	REFER TO ORDER			SHEET 1 OF 1	REV. 1		
DRAWING LEGEND	N.W.	149 kg	Product Size	1730X700X715	 KASKADE STONE www.kaskadebaths.de			
	G.W.	kg	Package size					
	LINEAR / ANGULAR TOLERANCES		DRAWN	KASKADE			DATE	02/03/15
	No Decimals	1 Decimal	2 Decimals	CHK'D			DATE	
		±5				±3°		

REV	DESCRIPTION	DWG	DATE	CHK'D	DATE
1	RELEASE DATE.	KASKADE	02/03/15		