

DRAFT COPY

DO NOT SCALE. IF IN DOUBT ASK!

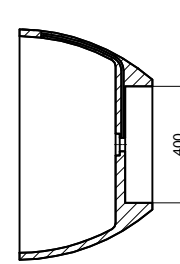

SECTION B-B

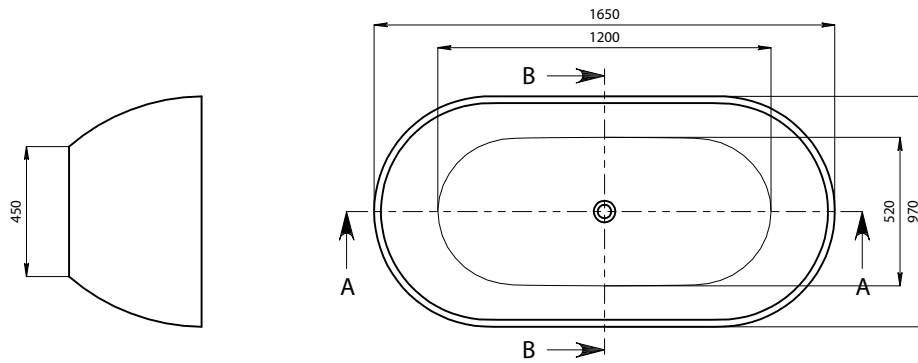
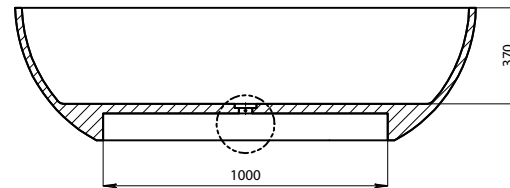
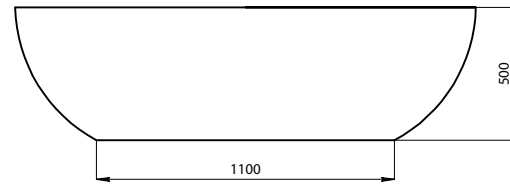
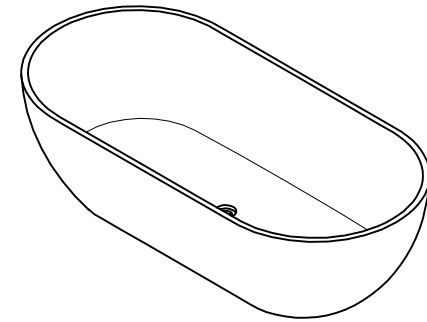

SECTION A-A

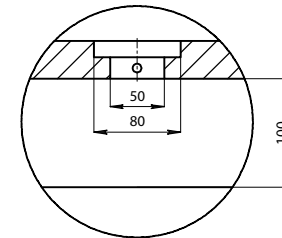

DETAIL D
SCALE 1:4

COLOUR
QTY
APPROVED BY:
NAME & SIGNATURE
DATE APPROVED:

- NOTES
- ALL INTERNAL CORNERS TO BE R5 UNLESS OTHERWISE STATED.
 - AS ALL KASKADE PRODUCTS ARE HAND FINISHED A 2-5mm TOLERANCE IS ALLOWED.

COPYRIGHT © APPLIES. DUPLICATION OF THIS DRAWING OR ANY SPECIFIC DESIGN FEATURES IS NOT PERMITTED WITHOUT WRITTEN AUTHORITY. "COMMERCIAL CONFIDENTIALITY" IS ASSUMED AND REQUIRED.

UNLESS OTHERWISE STATED ALL DIMENSIONS IN MILLIMETERS		MATERIAL: KASKADE STONE	DRAWING NUMBER Aveo-RS12-1650		SCALE 1:1	A4
DRAWING LEGEND		FINISH: REFER TO ORDER	Product Size 1650X970X500		SHEET 1 OF 1	REV. 1
N.W. 199 kg		G.W. kg		PACKAGE size		 www.kaskadebaths.de
LINEAR / ANGULAR TOLERANCES		DRAWN KASKADE		DATE 02/03/15		
No Decimals		1 Decimal		2 Decimals		
±5		±3		±0.1		

REV	DESCRIPTION	DWG	DATE	CHK'D	DATE
1	RELEASE DATE.	KASKADE	02/03/15		